

Urologie Urology

**Urologie /
Urology**

Zystoskope / Cystoscopes
Zubehör / Equipment

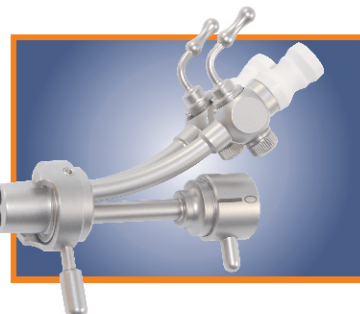
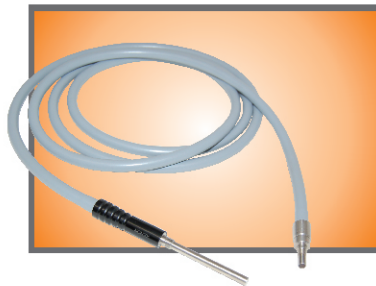
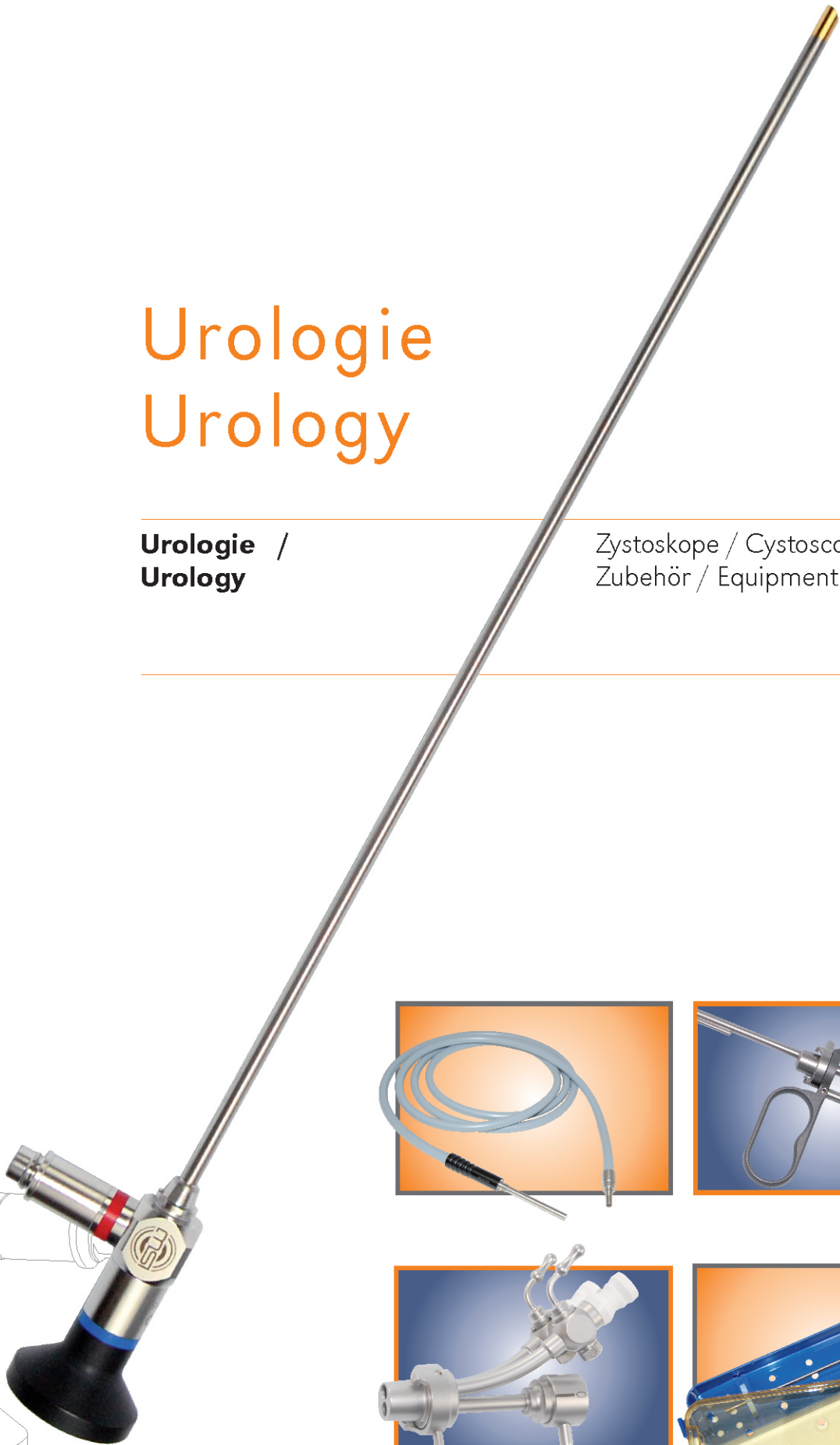
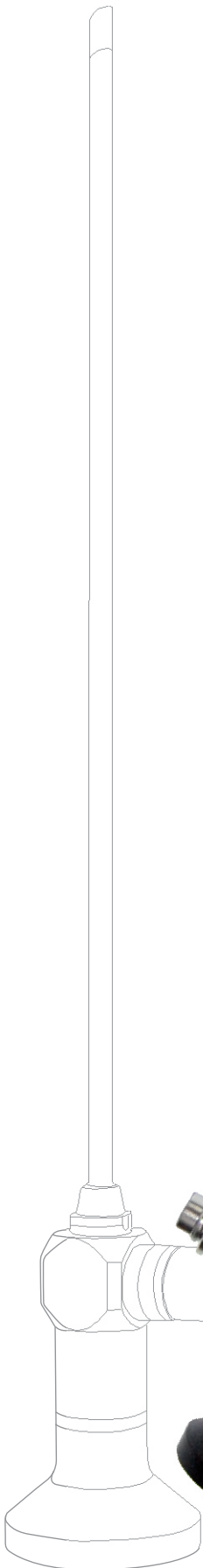

ZYSTOSKOPE CYSTOSCOPES

Minimalinvasive Diagnose und
Therapie
Minimal invasive diagnosis
and therapy

© bartekwardziak - Fotolia.com

- Lasergeschweißte Verbindungen
- brilliantes Bild
- korrosionsbeständig
- ergonomisches Design
- Decklinse aus Saphirglas

Die Symbiose aus Medizinpraxis
und Ingenieurwissen

- laser welded connections
- Crystal clear image
- Non-corrosive
- Ergonomic design
- Sapphire glass lens

The symbiosis of medical
knowledge and engineering
know-how



Zystoskopie Cystoscopy



autoklavierbar (134 °C / 270 F)
autoclavable (134 °C / 270 F)

ZYSTOSKOPE 300/4.0 + 303/4.0 Zystoskope

Komplett aus Edelstahl für höchste Korrosionsbeständigkeit.
Alle mechanischen Verbindungen sind lasergeschweißt. Distale und proximale Decklinsen bestehen aus Saphirglas und sind eingelötet. Das bedeutet keine Klebestellen, keine Undichtigkeit und kein Zerkratzen.
"High-Resolution" Optiksystem für besonders brillante Bildqualität.
MSI Endoskope sind kompatibel mit Schäften unterschiedlicher Hersteller.
Problemlose Integration der MSI Endoskope in Ihr bestehendes Zubehör Instrumentarium.
Unterschiedliche Blickrichtungen sind farblich gekennzeichnet.
Der blaue Ring bedeutet, dass das Endoskop autoklavierbar ist.

Blickrichtung *Direction of view*
Blickwinkel *Angle of view*

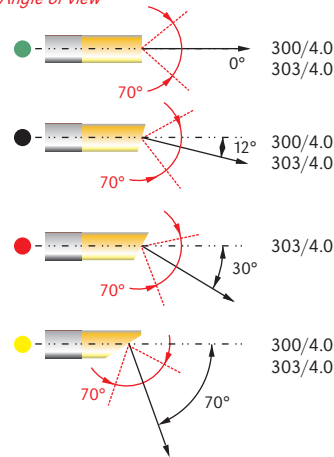

CYSTOSCOPES 300/4.0 + 303/4.0 Laparoscopes

Made entirely of non-corrosive, stainless steel.
All mechanical connections are laser-welded. Distal and proximal lenses are made of sapphire glass and are soldered in. This means no adhesive joints, no leaks, no scratches.
High-resolution optics offer brilliant high image quality. MSI Optics are compatible with the shafts of other manufacturers and they can be perfectly integrated into your existing equipment.
Optics come with a range of colour-coded angles of view. The blue ring stands for autoclavable.

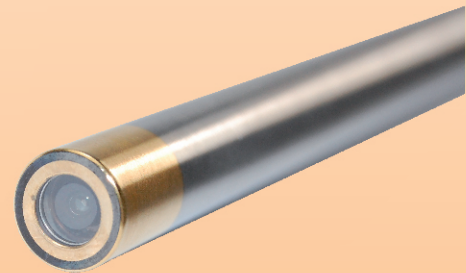

Auf Anfrage bieten wir Ihnen auch Kompatible Optiken anderer Hersteller an.
On request we also offer compatible optics of other manufacturers.

Kompatibel	Compatible	Storz	Storz	Storz	Storz	Storz	Storz	Storz	Wolf
Durchmesser	Diameter	2,7 mm	2,7 mm	2,7 mm	4 mm	4 mm	4 mm	4 mm	4 mm
Nutzlänge	Length	302 mm	302 mm	302 mm	302 mm	302 mm	302 mm	302 mm	300 mm
Blickrichtung	Direction of View	0°	30°	70°	0°	12°	30°	70°	0°
Öffnungswinkel	Flare angle	80°	80°	80°	70°	70°	70°	70°	70°
Artikel Nr.	Product No.	30 28 00	30 28 30	30 28 70	30 40 00	30 40 12	30 40 30	30 40 70	31 40 00

Kompatibel	Compatible	Wolf	Wolf	Wolf	Wolf	Olympus	Olympus	Olympus	Olympus
Durchmesser	Diameter	2,7 mm	4 mm	4 mm	4 mm	4 mm	4 mm	4 mm	4 mm
Nutzlänge	Length	300 mm	300 mm	300 mm	300 mm	280 mm	280 mm	280 mm	280 mm
Blickrichtung	Direction of View	30°	12°	30°	70°	0°	30°	12°	70°
Öffnungswinkel	Flare angle	70°	70°	70°	70°	Standard	Standard	Standard	Standard
Artikel Nr.	Product No.	31 28 30	31 40 12	31 40 30	31 40 70	32 40 00	32 40 30	32 40 12	32 40 70

URETERO-RENOSKOP URETERO-RENOSCOPE

**mit seitlich versetztem Einblick
with sidewise displaced view**

7,5 Charr. Kompakt
7,5 Charr. compact

Kompakt Uretero-Renoskop
mit seitlich versetztem Okulareinblick

- Semi flexibler Schaft
- Atraumatisch durch weiche Übergänge
- korrosionsbeständig
- ergonomisches Design
- Große Tiefenschärfe

Compact Uretero-Renoscope
with sidewise displaced view

- Semi-flexible shaft
- Non-traumatic due to soft transitions
- Non-corrosive
- Ergonomic design
- Great depth of field

© smart wizard - Fotolia.com



Urologie Urology

URETERO-RENOSKOP mit seitlich versetztem Einblick *URETERO-RENOSCOPE with sidewise displaced view*

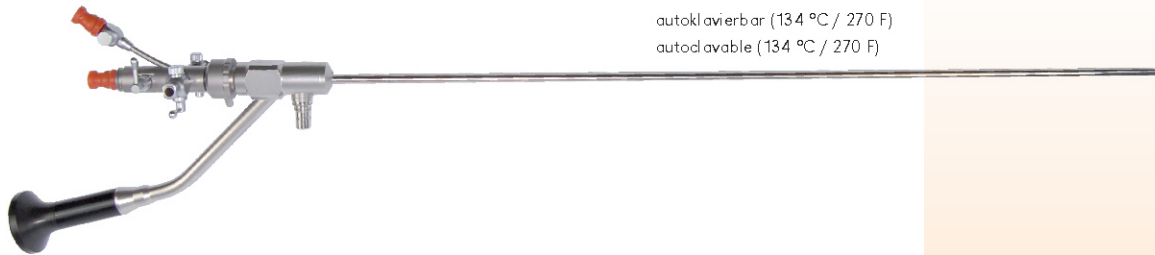

autoklavierbar (134 °C / 270 F)
autoclavable (134 °C / 270 F)

Kompakt *URETERO-RENOSKOP*

mit seitlich versetztem Okulareinblick

- Semi flexibler Schaft
- Distales Ende mit atraumatischer Form
- Hochauflösendes Bildbündel
- Autoklavierbar
- Platzierung von Instrumenten mit ausreichender Spülung möglich
- Große Tiefenschärfe
- Optionaler Halter für Ultraschall-/elektrohydraulische Sonden zum Aufschrauben, z.B. EMS
- Arbeitsbrücke mit Schnellkupplung, kompatibel zur Fremdmarke Wolf
- Fixfocus

Stabilität des Schaftes

- Phynox Rohre ca. 1.700-2.200 N/mm²
- starkes Elastizitätsmodul

Schaftform Außen

- Aus einem Phynoxrohr gezogen
- Keine scharfen Übergänge
- Atraumatisch durch weiche Übergänge



Stability of the shaft

- Phynox tubes approx. 1.700-2.200 N/mm²
- strong elasticity module

Outer form of shaft

- Torn out of a Phynox tube
- No sharp transitions
- Non-traumatic due to soft transitions

Technische Daten

- Arbeitsquerschnitt:
distal 7,5 Charr.
erste Stufe 9,8 Charr.
- Arbeitskanal: 1,67 mm x 1,85 mm
1 x 5 Charr., oder
2 x 3 Charr.
- Blickrichtung: 8° zum Arbeitskanal
- Öffnungswinkel: 85°

Artikel Nr. *Product No.*

36 52 00

Flexibilität des kompakten Uretero-Renoskop 7,5 Charr.

Flexibility of the compact Uretero-Renoscope 7,5 Charr.

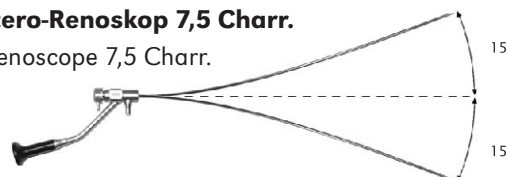

Compact *URETERO-RENOSCOPE*

with sidewise displaced view

- Semi-flexible shaft
- Distal end with non-traumatic form
- High-resolution image bundle
- Autoclavable
- Positioning of instrument with sufficient rinsing possible
- Great depth of field
- Optional mount for ultrasonic or electrohydraulic probes to be screwed on, e.g. EMS
- Adapter with quick fitting coupling compatible to the competitor's brand Wolf
- Fixed focus

Technical data

- Operating cross-section:
distal 7,5 Charr.
first level 9,8 Charr.
- Biopsy channel: 1,67 mm x 1,85 mm
1 x 5 Charr., oder
2 x 3 Charr.
- Direction of view: 8° towards biopsy channel
- Flare angle: 85°

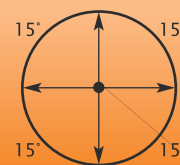

Adapter für EMS Lithotriptor

Adapter for EMS Lithotriptor

Artikel Nr. *Product No.*

36 45 00



Urologie Urology

Mini-URETERO-RENOSKOP mit seitlich versetztem Einblick
Mini-URETERO-RENOSCOPE with sidewise displaced view

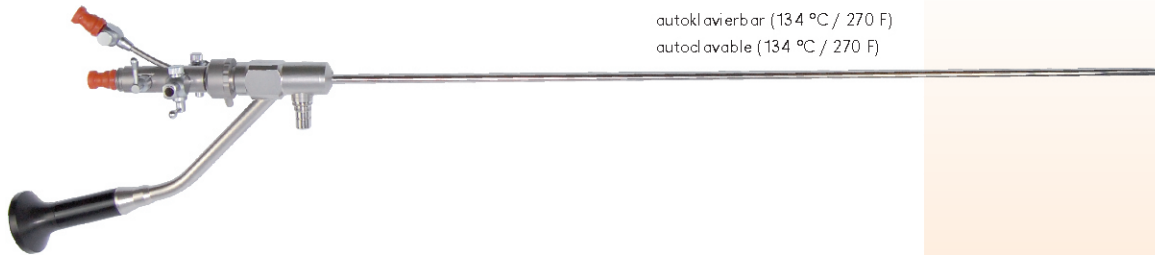

Kompakt

Mini-URETERO-RENOSKOP

mit seitlich versetztem Okulareinblick

- Semi flexibler Schaft
- Distales Ende mit atraumatischer Form
- Hochauflösendes Bildbündel
- Autoklavierbar
- Platzierung von Instrumenten mit ausreichender Spülung möglich
- Große Tiefenschärfe
- Optionaler Halter für Ultraschall-/ elektrohydraulische Sonden zum Aufschrauben, z.B. EMS
- Arbeitsbrücke mit Schnellkupplung, kompatibel zur Fremdmarke Wolf
- Fixfocus

Stabilität des Schaftes

- Phynox Rohre ca. 1.700-2.200 N/mm²
- starkes Elastizitätsmodul

Schaftform Außen

- Aus einem Phynoxrohr gezogen
- Keine scharfen Übergänge
- Atraumatisch durch weiche Übergänge



Stability of the shaft

- Phynox tubes approx. 1.700-2.200 N/mm²
- strong elasticity module

Outer form of shaft

- Torn out of a Phynox tube
- No sharp transitions
- Non-traumatic due to soft transitions

Technische Daten

- Arbeitsquerschnitt:
distal 6 Charr.
erste Stufe 7,5 Charr.
- Arbeitskanal: 1 x 4 Charr., oder
2 x 2,4 Charr.
- Blickrichtung: 8° zum Arbeitskanal
- Öffnungswinkel: 100°
- Schaftlänge: 425 mm

Artikel Nr. *Product No.*

36 62 00

Flexibilität des kompakten Mini-Uretero-Renoskop 6 Charr.

Flexibility of the compact Mini-Uretero-Renoscope 6 Charr.

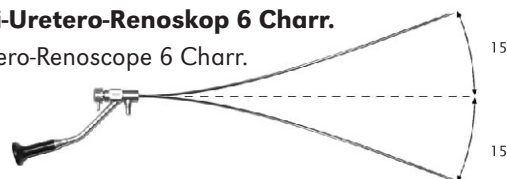

Compact

Mini-RETERO-RENOSCOPE

with sidewise displaced view

- Semi-flexible shaft
- Distal end with non-traumatic form
- High-resolution image bundle
- Autoclavable
- Positioning of instrument with sufficient rinsing possible
- Great depth of field
- Optional mount for ultrasonic or electrohydraulic probes to be screwed on, e.g. EMS
- Adapter with quick fitting coupling compatible to the competitor's brand Wolf
- Fixed focus

Technical data

- Operating cross-section:
distal 6 Charr.
first level 7,5 Charr.
- Biopsy channel: 1 x 4 Charr., oder
2 x 2,4 Charr.
- Direction of view: 8° towards biopsy channel
- Flare angle: 100°
- Sheath length: 425 mm



Adapter für EMS Lithotriptor

Adapter for EMS Lithotriptor

Artikel Nr. *Product No.*

36 45 00





URETERO-RENOSKOP gerade

URETERO-RENOSCOPE straight

7,5 Charr. Kompakt
7,5 Charr. compact

Kompakt Uretero-Renoskop
mit geradem Okulareinblick

- Semi flexibler Schaft
- Atraumatisch durch weiche Übergänge
- korrosionsbeständig
- ergonomisches Design
- Große Tiefenschärfe

Compact Uretero-Renoscope
with straight view

- Semi-flexible shaft
- Non-traumatic due to soft transitions
- Non-corrosive
- Ergonomic design
- Great depth of field



© smart wizard - Fotolia.com

URETERO-RENOSKOP gerade **URETERO-RENOSCOPE straight**

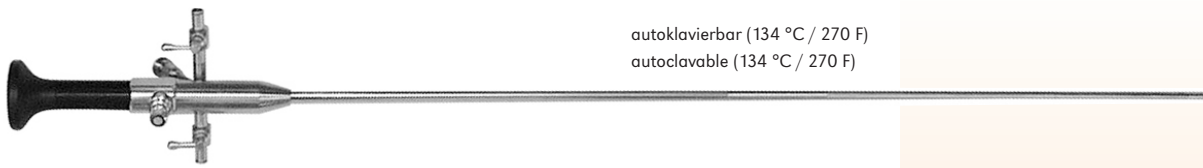

autoklavierbar (134 °C / 270 F)
autoclavable (134 °C / 270 F)

Kompakt **URETERO-RENOSKOP**

mit geradem Okulareinblick

- Semi flexibler Schaft
- Distales Ende mit atraumatischer Form
- Hochauflösendes Bildbündel
- Autoklavierbar
- Platzierung von Instrumenten mit ausreichender Spülung möglich
- Große Tiefenschärfe
- Fixfocus

Technische Daten

- Arbeitsquerschnitt:
distal 7,5 Charr.
erste Stufe 9,8 Charr.
- Arbeitskanal: 1,67 mm x 1,85 mm
1 x 5 Charr.
- Blickrichtung: 8° zum Arbeitskanal
- Öffnungswinkel: 85°

Stabilität des Schaftes

- Phynox Rohre ca. 1.700-2.200 N/mm²
- starkes Elastizitätsmodul

Schaftform Außen

- Aus einem Phynoxrohr gezogen
- Keine scharfen Übergänge
- Atraumatisch durch weiche Übergänge



Stability of the shaft

- Phynox tubes approx. 1.700-2.200 N/mm²
- strong elasticity module

Outer form of shaft

- Torn out of a Phynox tube
- No sharp transitions
- Non-traumatic due to soft transitions

Artikel Nr. *Product No.*

36 42 00

Flexibilität des kompakten Uretero-Renoskop 7,5 Charr.

Flexibility of the compact Uretero-Renoscope 7,5 Charr.

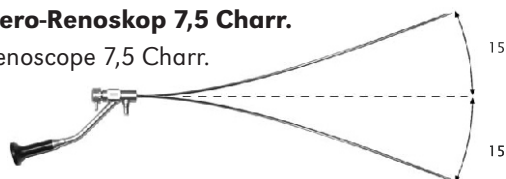

Compact **URETERO-RENOSCOPE**

with straight ocular view

- Semi-flexible shaft
- Distal end with non-traumatic form
- High-resolution image bundle
- Autoclavable
- Positioning of instrument with sufficient rinsing possible
- Great depth of field
- Fixed focus

Technical data

- Operating cross-section:
distal 7,5 Charr.
first level 9,8 Charr.
- Biopsy channel: 1,67 mm x 1,85 mm
1 x 5 Charr.
- Direction of view: 8° towards biopsy channel
- Flare angle: 85°

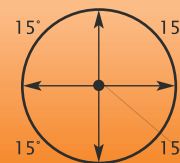

Adapter für EMS Lithotriptor

Adapter for EMS Lithotriptor

Artikel Nr. *Product No.*

36 45 00



Urology Zubehör Urology equipment

Elektrotransporteur / Arbeitselement
Electrodes transporting / working element

Arbeitselement, passiv Hauptgriff geschlossen
Working element, passive, closed



Artikel Nr. *Product No.* **37 10 00**

Arbeitselement, passiv Hauptgriff offen
Working element, passive, open

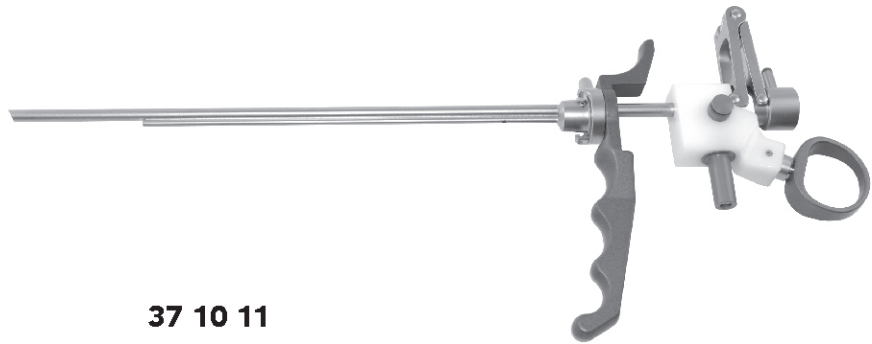

Artikel Nr. *Product No.* **37 10 11**

Arbeitselement, aktiv Hauptgriff offen
Working element, active, open



Artikel Nr. *Product No.* **37 10 21**

Arbeitselement, aktiv Hauptgriff geschlossen
Working element, active, closed



Artikel Nr. *Product No.* **37 10 20**

Urology Zubehör Urology equipment

Elektrotransporteur / Arbeitselement
Electrodes transporting / working element

Arbeitselement, McCarthy
Working element, McCarthy

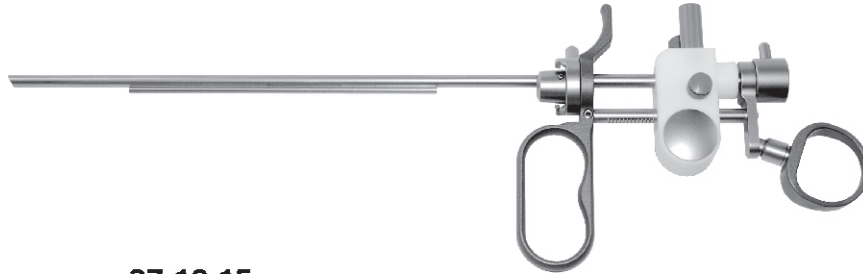

Artikel Nr. *Product No.* **37 10 15**

Füllstab für Arbeitselement

Filled rod for working element



Artikel Nr. *Product No.* **37 10 22**

HF Anschlußkabel

HF adaptor cable

HF Anschlusskabel Martin

HF connection cable Martin



Durchmesser	<i>Diameter</i>	4 mm	4 mm
Nutzlänge	<i>Length</i>	3000 mm	5000 mm
Artikel Nr.	<i>Product No.</i>	90 00 00	90 00 05

HF Anschlusskabel Erbe-ACC/ICC

HF connection cable Erbe-ACC/ICC



Durchmesser	<i>Diameter</i>	5 mm
Nutzlänge	<i>Length</i>	3000 mm
Artikel Nr.	<i>Product No.</i>	90 00 15

5000 mm Nutzlänge auf Anfrage /
5000 mm Length on request

HF Anschlusskabel Valleylab-Bovie

HF connection cable Valleylab-Bovie



Durchmesser	<i>Diameter</i>	8 mm
Nutzlänge	<i>Length</i>	3000 mm
Artikel Nr.	<i>Product No.</i>	90 00 25

5000 mm Nutzlänge auf Anfrage /
5000 mm Length on request

Standard Resektoskopschäfte *Standard Resectoscope sheaths*

Standard Schaft

Standard Sheath



Schaft	<i>Sheath</i>	24 Charr./Fr.	27 Charr./Fr.
Obturator	<i>Obturator</i>	ohne	ohne
Artikel Nr.	<i>Product No.</i>	37 11 03	37 11 04

Resektoskopschäfte mit Zentralthahn ohne Obturator *Resectoscope sheaths with central stopcock without obturator*



Schaft	<i>Sheath</i>	24 Charr./Fr.	27 Charr./Fr.
Obturator	<i>Obturator</i>	ohne	ohne
Artikel Nr.	<i>Product No.</i>	37 12 03	37 12 04

Standard Obturator

Standard Obturator

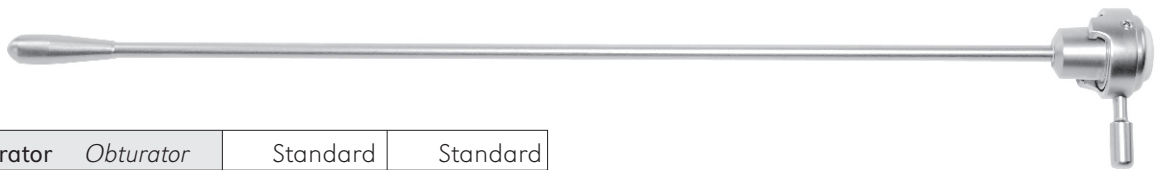

Obturator	<i>Obturator</i>	Standard	Standard
Charr.	<i>Fr.</i>	24/26	27
Artikel Nr.	<i>Product No.</i>	37 12 05	37 12 06

Resektoskopschäfte mit feststehendem Innenschaft 26Charr.

Resectoscope sheaths 26Fr. with fixed inner sheath

Dauerspülschaft komplett 26Charr. *Continuous flow sheath. compl. 26Fr.*



Artikel Nr. *Product No.* **37 13 01**

Dauerspülschaft komplett 26Charr. drehbar

Continuous flow sheath. compl. 26Fr. rotating



Artikel Nr. *Product No.* **37 13 10**

Innenschaft für Resektoskop 26Charr.

Inner sheath for resectoscope 26Fr.









Artikel Nr. *Product No.* **37 13 02**

Aussenschaft für Resektoskop 26Charr.

Outer sheath for resectoscope 26Fr.



Perforation <i>Perforation</i>						
	rundum/ all around	unten/ bottom	oben/ top	oben/unten top/bottom	rundum/langloch all around/long hole	langloch/oben long hole/top
Charr. <i>Fr.</i>	26	26	26	26	26	26
Artikel Nr. <i>Product No.</i>	37 13 03	37 13 04	37 13 05	37 13 06	37 13 07	37 13 08

Urology Zubehör Urology equipment

Resektoskopschäfte mit drehbarem Innenschaft 28.5Charr.
Resectoscope sheaths 28.5Fr. with rotating inner sheath

Dauerspülschaft komplett 28.5Charr. drehbar
Continous flow sheath complete 28.5Fr.

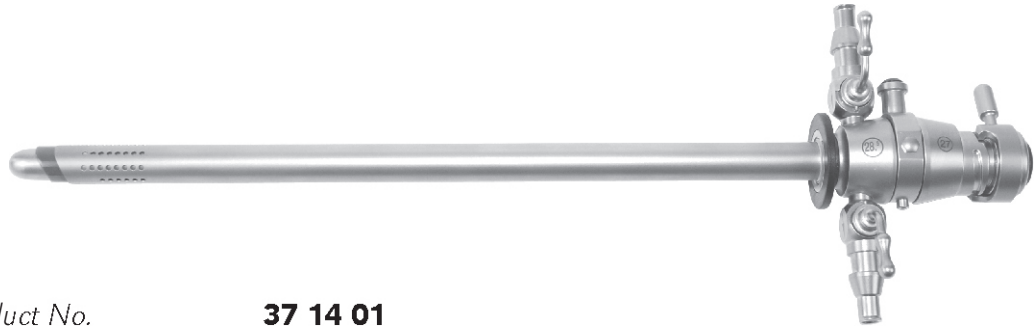

Artikel Nr. *Product No.* **37 14 01**



Innenschaft für Resektoskop 28.5Charr. drehbar
Inner sheath for resectoscope 28.5Fr. rotatable



Artikel Nr. *Product No.* **37 14 02**

Aussenschaft für Resektoskop 28.5Ch, drehbar
Outer sheath for resectoscope 28.5Fr rotatable



Perforation	<i>Perforation</i>		
		rundum/ all around	langloch/oben long hole/top
Charr.	<i>Fr.</i>	28,5	28,5
Artikel Nr.	<i>Product No.</i>	37 14 03	37 14 04

Standard Obturator

Standard Obturator



Charr.	<i>Fr.</i>	24/26	28,5
Artikel Nr.	<i>Product No.</i>	37 13 09	37 14 05

Obturatoren für Resektoskopschäfte *Obturator for Resectoscope sheaths*

Standard Obturator

Standard Obturator



Charr.	Fr.	24/26	28,5	24	27	28,5
Artikel Nr.	Product No.	37 13 09	37 14 05	37 12 05	37 12 06	37 14 05

Beweglicher Obturator

Movable obturator

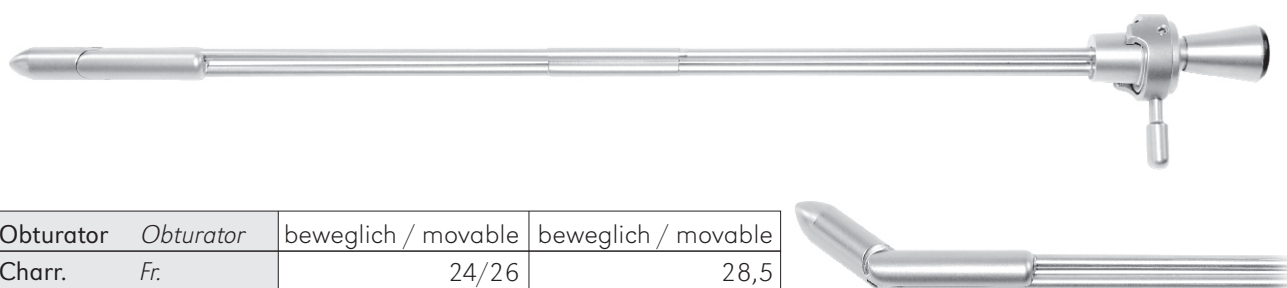

Obturator	Obturator	beweglich / movable	beweglich / movable
Charr.	Fr.	24/26	28,5
Artikel Nr.	Product No.	37 14 08	37 14 06

Sichtobturator ohne Kanal

Visual obturator without channel



Obturator	Obturator	28,5 Charr./Fr.	24/26 Charr./Fr.	24/26 Charr./Fr.
Artikel Nr.	Product No.	37 14 07	37 13 11	37 13 13

Sichtobturator mit Kanal

Visual obturator with channel







Obturator	Obturator	24/26 Charr./Fr.	28,5 Charr./Fr.
Kanal	Channel	5 Charr./Fr.	7 Charr./Fr.
Artikel Nr.	Product No.	37 13 12	37 14 09



Urology Zubehör Urology equipment





HF-Elektroden HF-Electrodes



HF-Elektroden 24 Charr. und 27 Charr. HF-Electrodes 24 Fr. and 27 Fr.



Elektrode	Electrode	Schlingen Elektrode HF loop electrode	Schlingen Elektrode HF loop electrode	Schlingen Elektrode HF loop electrode	Messer Elektrode HF knife electrode
					
Charr.	Fr.	24	24	24	24
Beschreibung	Description	gebogen 30° curved 30°	gerade straight	0°	
Artikel Nr.	Product No.	37 05 01	37 05 02	37 05 03	37 05 04

Elektrode	Electrode	Schlingen Elektrode HF loop electrode	Schlingen Elektrode HF loop electrode	Schlingen Elektrode HF loop electrode
				
Charr.	Fr.	27	27	27
Beschreibung	Description	gebogen 30° curved 30°	gerade straight	0°
Artikel Nr.	Product No.	37 06 01	37 06 02	37 06 03





Elektrode	Electrode	Kugel Elektrode HF ball electrode	Kugel Elektrode HF ball electrode	Rollen Elektrode HF roll electrode	Rollen Elektrode HF roll electrode
					
Charr.	Fr.	24	24	24	24
Beschreibung	Description	Ø 3 mm	Ø 5 mm	Ø 3 mm	Ø 5 mm
Artikel Nr.	Product No.	37 05 05	37 05 06	37 05 07	37 05 08

Elektrode	Electrode	HF Kegel Elektrode HF conus electrode	HF Spike Elektrode HF spike electrode	HF Spike Elektrode HF spike electrode
				
Charr.	Fr.	24	24	24
Beschreibung	Description		Ø 3 mm	Ø 5 mm
Artikel Nr.	Product No.	37 05 09	37 05 10	37 05 11

HF-Elektroden HF-Electrodes

HF-Elektroden 24 Charr. und 27 Charr. HF-Electrodes 24 Fr. and 27 Fr.



Elektrode <i>Electrode</i>	Vaporisations Elektr. <i>Vaporization electr.</i>	Vaporisations Elektr. <i>Vaporization electr.</i>	Kürette, scharf <i>Curette, sharp</i>	Messer Elektrode <i>HF knife electrode</i>
				
Charr. <i>Fr.</i>	24	24	24	24
Beschreibung <i>Description</i>	Ø 3 mm	Ø 5 mm	scharf, rund <i>sharp, round</i>	
Artikel Nr. <i>Product No.</i>	37 05 12	37 05 13	37 05 14	37 05 15

Elektrode <i>Electrode</i>	Kürette, scharf <i>Curette, sharp</i>	HF Band Elektrode <i>HF band electrode</i>
		
Charr. <i>Fr.</i>	27	27
Beschreibung <i>Description</i>	scharf, rund <i>sharp, round</i>	für 0° Optik <i>for 0° Optic</i>
Artikel Nr. <i>Product No.</i>	37 06 04	37 06 05

Elektrode <i>Electrode</i>	HF Band Elektrode <i>HF band electrode</i>	HF Schaber stumpf <i>HF scraper, blunt</i>	HF Band-Vaporisations Elektr. <i>HF band-vaporization electr.</i>	HF Band Elektrode <i>HF band electrode</i>
Charr. <i>Fr.</i>	24	24	24	24
Beschreibung <i>Description</i>	für 0° Optik <i>for 0° Optic</i>	stumpf <i>blunt</i>	Vaporisation <i>vaporisation</i>	für 30° Optik <i>for 30° Optic</i>
Artikel Nr. <i>Product No.</i>	37 05 16	37 05 17	37 05 18	37 05 19



Elektrode <i>Electrode</i>	HF Nadel Elektrode <i>HF needle electrode</i>
	
Charr. <i>Fr.</i>	24
Beschreibung <i>Description</i>	abgewinkelt <i>angled</i>
Artikel Nr. <i>Product No.</i>	37 05 20

HF-Elektroden

HF-Electrodes

HF Elektroden für Resektoskope - doppelläufig

HF Resectoscopes - double system

Elektrode <i>Electrode</i>	Schneideschlinge <i>Cutting Loop</i>	Schneideschlinge <i>Cutting Loop</i>	Spike Elektrode <i>spike electrode</i>	Spike Elektrode <i>spike electrode</i>
				
Charr. <i>Fr.</i>	24	24	24	24
Beschreibung <i>Description</i>	abgewinkelt 30° <i>bent 30°</i>	90° 90°	Ø 3mm	Ø 5mm
Artikel Nr. <i>Product No.</i>	37 80 01	37 80 02	37 80 03	37 80 04

Elektrode <i>Electrode</i>	Koagulations Elektrode <i>Coagulation electrode</i>	Koagulations Elektrode <i>Coagulation electrode</i>	Koagulations Elektrode <i>Coagulation electrode</i>	Koagulations Elektrode <i>Coagulation electrode</i>
Charr. <i>Fr.</i>	24	24	24	24
Beschreibung <i>Description</i>	Kugel Ø 3mm <i>ball Ø 3mm</i>	Kugel Ø 5mm <i>ball Ø 5mm</i>	zylinderförmig Ø 3mm <i>cylindrical Ø 3mm</i>	zylinderförmig Ø 5mm <i>cylindrical Ø 5mm</i>
Artikel Nr. <i>Product No.</i>	37 80 12	37 80 05	37 80 06	37 80 07

Elektrode <i>Electrode</i>	Koagulations Elektrode <i>Coagulations electrode</i>	Koagulations Elektrode <i>Coagulations electrode</i>	Rollen Elektrode <i>Roll electrode</i>	Rollen Elektrode <i>Roll electrode</i>
Charr. <i>Fr.</i>	24	24	24	24
Beschreibung <i>Description</i>	spitz <i>pointed</i>	konisch <i>conical</i>	Ø 3mm	Ø 5mm
Artikel Nr. <i>Product No.</i>	37 80 08	37 80 09	37 80 10	37 80 11

Sterilisierhülse für Elektroden Sterilisation tube for Electrodes





Artikel Nr. *Product No.* 37 55 01





Urology Zubehör Urology equipment



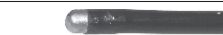

HF-Elektroden HF-Electrodes



Flexible Elektrode mit 2mm HF-Anschluss - Arbeitslänge 450 mm Flexible electrode with 2mm HF-connection - Working length 450 mm



Elektrode	Electrode	flex. Nadel Elektrode flex. needle electrode	flex. Nadel Elektrode flex. needle electrode	flex. Knopf Elektrode flex. button electrode	flex. Knopf Elektrode flex. button electrode
					
Charr.	Fr.	4	3	3	4
Arbeitslänge	Working length	450 mm	450 mm	450 mm	450 mm
Artikel Nr.	Product No.	37 65 01	37 65 02	37 65 03	37 65 04

Elektrode	Electrode	flex. Knopf Elektrode flex. button electrode	flex. Knopf Elektrode flex. button electrode	flex. Knopf Elektrode flex. button electrode	flex. Nadel Elektrode flex. needle electrode
					
Charr.	Fr.	5	6	7	5
Arbeitslänge	Working length	450 mm	450 mm	450 mm	450 mm
Artikel Nr.	Product No.	37 65 05	37 65 06	37 65 07	37 65 08

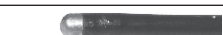
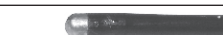
Elektrode	Electrode	flex. Nadel Elektrode flex. needle electrode	flex. Schlingen Elektrode flex. loop electrode	flex. Schlingen Elektrode flex. loop electrode	flex. Schlingen Elektrode flex. loop electrode
					
Charr.	Fr.	7	5	7	9
Arbeitslänge	Working length	450 mm	450 mm	450 mm	450 mm
Artikel Nr.	Product No.	37 65 09	37 65 10	37 65 11	37 65 12

Elektrode	Electrode	flex. Knopf Elektrode flex. button electrode	flex. Knopf Elektrode flex. button electrode	flex. Knopf Elektrode flex. button electrode	flex. Schlingen Elektrode flex. loop electrode
					
Charr.	Fr.	9	8	10	10
Arbeitslänge	Working length	450 mm	450 mm	450 mm	450 mm
Artikel Nr.	Product No.	37 65 13	37 65 14	37 65 15	37 65 16

Urology Zubehör Urology equipment





HF-Elektroden





HF-Electrodes





Flexible Elektrode mit 2mm HF-Anschluss - Arbeitslänge 650 mm





Flexible electrode with 2mm HF-connection - Working length 650 mm



Elektrode	Electrode	flex. Nadel Elektrode flex. needle electrode	flex. Nadel Elektrode flex. needle electrode	flex. Knopf Elektrode flex. button electrode	flex. Knopf Elektrode flex. button electrode
					
Charr.	Fr.	4	3	3	4
Arbeitslänge	Working length	450 mm	450 mm	450 mm	450 mm
Artikel Nr.	Product No.	37 70 01	37 70 02	37 70 03	37 70 04

Elektrode	Electrode	flex. Knopf Elektrode flex. button electrode	flex. Knopf Elektrode flex. button electrode	flex. Knopf Elektrode flex. button electrode	flex. Nadel Elektrode flex. needle electrode
					
Charr.	Fr.	5	6	7	5
Arbeitslänge	Working length	450 mm	450 mm	450 mm	450 mm
Artikel Nr.	Product No.	37 70 05	37 70 06	37 70 07	37 70 08

Elektrode	Electrode	flex. Nadel Elektrode flex. needle electrode	flex. Schlingen Elektrode flex. loop electrode	flex. Schlingen Elektrode flex. loop electrode	flex. Schlingen Elektrode flex. loop electrode
					
Charr.	Fr.	7	5	7	9
Arbeitslänge	Working length	450 mm	450 mm	450 mm	450 mm
Artikel Nr.	Product No.	37 70 09	37 70 10	37 70 11	37 70 12

Elektrode	Electrode	flex. Knopf Elektrode flex. button electrode	flex. Knopf Elektrode flex. button electrode	flex. Knopf Elektrode flex. button electrode	flex. Schlingen Elektrode flex. loop electrode
					
Charr.	Fr.	9	8	10	10
Arbeitslänge	Working length	450 mm	450 mm	450 mm	450 mm
Artikel Nr.	Product No.	37 70 13	37 70 14	37 70 15	37 70 16

Zystoskop-Urethroskope für Erwachsene

Cystoscope-Urethroscopes for adults

Zystoskop Schaft ohne Obturator

Cystoscope sheath without obturator



Charr.	Fr.	15	17	19	21	23	25
Kennfarbe	Colour Code	schwarz / black	gelb / yellow	grün / green	rot / red	blau / blue	weiß / white
Artikel Nr.	Product No.	37 50 15	37 50 17	37 50 19	37 50 21	37 50 23	37 50 25

Obturator für Zystoskopschaft

Obturator for Cystoscope sheath

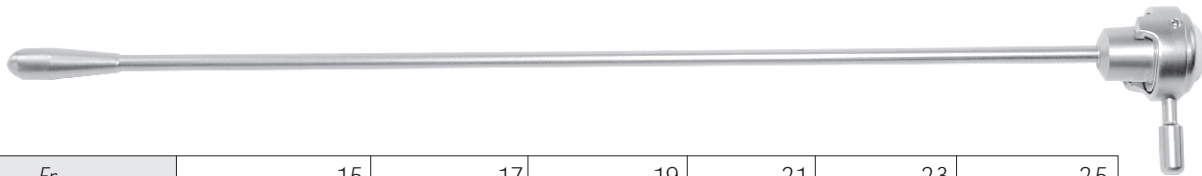

Charr.	Fr.	15	17	19	21	23	25
Kennfarbe	Colour Code	schwarz / black	gelb / yellow	grün / green	rot / red	blau / blue	weiß / white
Artikel Nr.	Product No.	37 51 15	37 51 17	37 51 19	37 51 21	37 51 23	37 51 25

Zystoskop Schaft mit Zentralhahn ohne Obturator

Cystoscope sheath with central stopcock without obturator

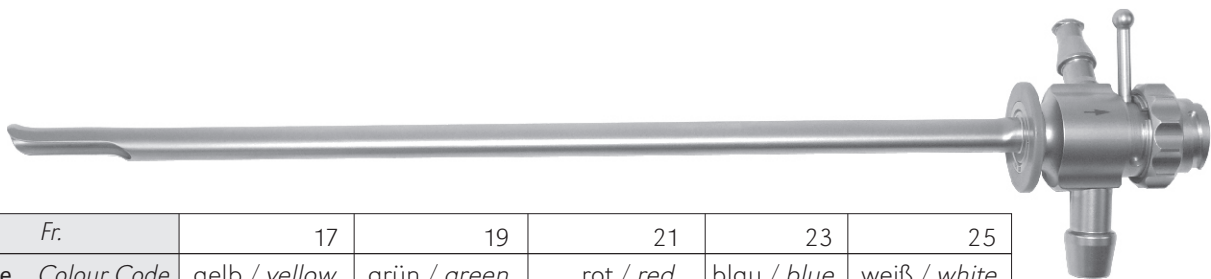

Charr.	Fr.	17	19	21	23	25
Kennfarbe	Colour Code	gelb / yellow	grün / green	rot / red	blau / blue	weiß / white
Artikel Nr.	Product No.	37 52 17	37 52 19	37 52 21	37 52 23	37 52 25

Sichtobturatoren

Visual Obturators

Sichtobturatoren

Visual Obturators

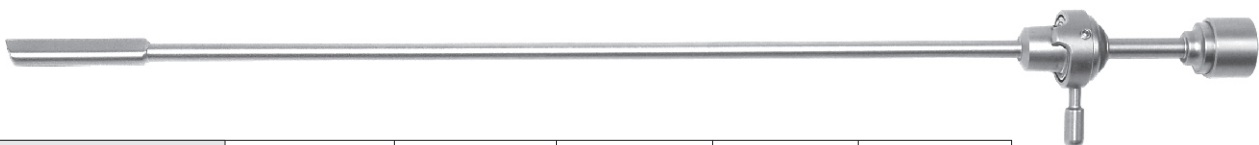

Kennfarbe	Colour Code	gelb / yellow	grün / green	rot / red	blau / blue	weiß / white
Charr.	Fr.	17	19	21	23	25
Artikel Nr.	Product No.	37 26 01	37 26 02	37 26 03	37 26 04	37 26 05

Urology Zubehör Urology equipment

Uretrotome für Erwachsene, für 0° Optik

Urethrotome for adults, for 0° Optic

Urethrotom Schaft 21 Charr. ohne Obturator

Urethrotome sheath 21 Fr. without obturator

Ohne Obturator
Without obturator



Artikel Nr. *Product No.* **38 10 01**

Obturator für Urethrotom Schaft 21 Charr. mit 5 Charr. Kanal

Obturator for Urethrotome sheath 21 Fr. with 5 Fr. channel



Artikel Nr. *Product No.* **38 10 02**

Untersuchungseinsatz mit 1 Kanal 5 Charr. *Optical bridge with 1 channel Fr.*

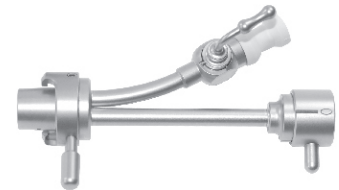

Artikel Nr. *Product No.* **38 10 03**

Zusatzschaft, seitlich offen

Outer sheath, half round



Artikel Nr. *Product No.* **38 10 04**

Dauerspül-Zusatzschaft

Outer sheath



Artikel Nr. *Product No.* **38 10 05**

Obturator für Urethrotom Schaft 21 Charr. ohne Kanal

Obturator for Urethrotome sheath 21 Fr. without channel



Artikel Nr. *Product No.* **38 10 06**

Sichtobturator für Urethrotomschaft *Visual obturator for Urethrotome sheath*







Artikel Nr. *Product No.* **38 10 07**

Urology Zubehör Urology equipment

Uretrotome für Erwachsene, für 0° Optik *Urethrotome for adults, for 0° Optic*

Striktur Messer

Constriction knife

					
Beschreibung <i>Description</i>	gerade <i>straight</i>	rund <i>round</i>	gerade, Wellenschliff <i>straight, serrated</i>	ringförmig <i>ring-shaped</i>	hackenförmig <i>hook-shaped</i>
Artikel Nr. <i>Product No.</i>	38 10 08	38 10 09	38 10 10	38 10 11	38 10 12

Urologie Zubehör *Urology equipment*

Evakuator nach ELLIK

Evacuator ELLIK



Artikel Nr. *Product No.* **38 20 01**

Schaftanschluß für ELLIK

Connector for ELLIK

Artikel Nr. *Product No.* **38 20 02**

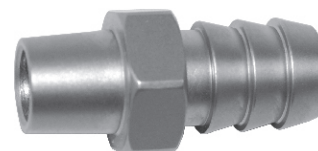

Konus mit Verriegelung für ELLIK

Connector with locking for ELLIK

Artikel Nr. *Product No.* **38 20 03**



Urology Zubehör Urology equipment

**Urologie Zubehör
Urology equipment**

Glasbehälter alleine

Glass container only

Artikel Nr. *Product No.*

38 20 04



Gummiball alleine

Bulb only

Artikel Nr. *Product No.*

38 20 05

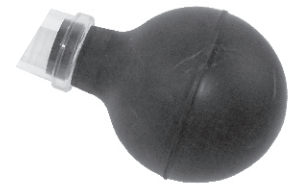

Luer-Lock Schlauchverbinder

Luer-Lock tube connector

Artikel Nr. *Product No.*

38 20 06



**Luer-Lock Schlauchverbinder mit Hahn
Luer-Lock tube connector with stopcock**

Artikel Nr. *Product No.*

38 20 07

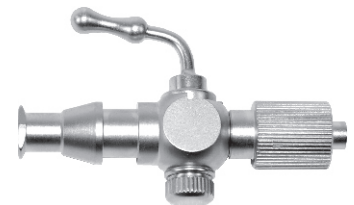

Siebplatte

Sieve plate

Artikel Nr. *Product No.*

38 20 08

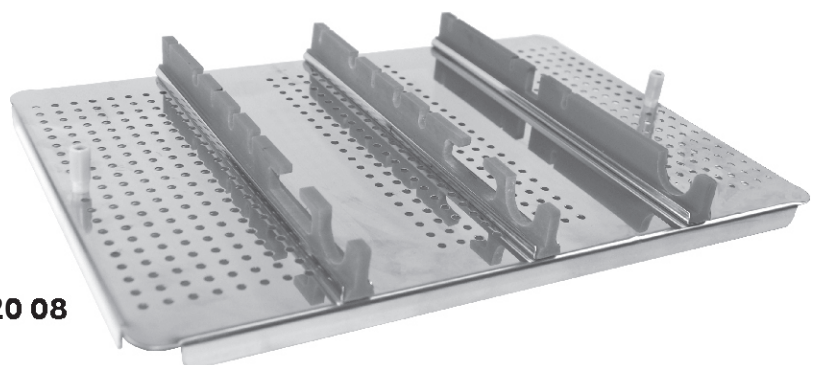

Urologie Zubehör - Arbeitseinsätze / Schafteinsätze
Urology equipment - working element / sheath element

Untersuchungseinsatz Diagnostik

Optical bridge diagnostic

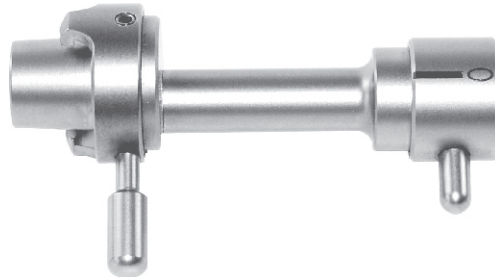

Artikel Nr. *Product No.*

37 20 00

Untersuchungseinsatz mit 1 Instrumenten-Kanal
Optical bridge with 1 instrument channel

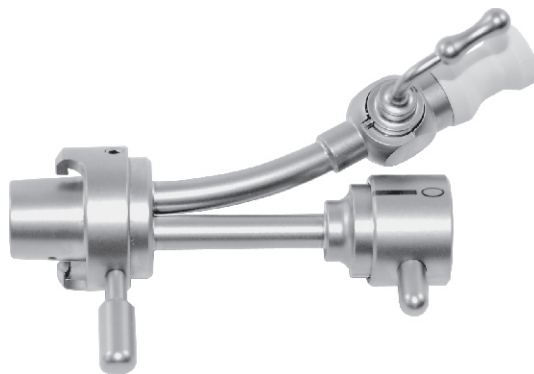

Artikel Nr. *Product No.*

37 20 01

Untersuchungseinsatz mit 2 Instrumenten-Kanälen
Optical bridge with 2 instrument channels

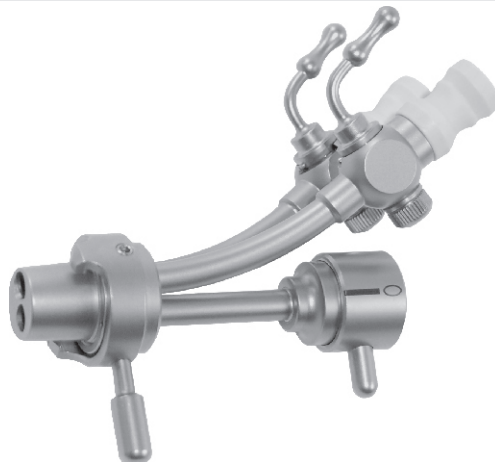

Artikel Nr. *Product No.*

37 20 02

Urology Zubehör Urology equipment

Arbeitseinsätze - Schafteinsätze - Optische Brücken *Working insertions - sheath insertions - optical bridges*

Arbeitseinsatz mit Albarran Lenkhebel, 1 Instrumenten-Kanal *Working element with Albarran deflecting, 1 instrument channel*

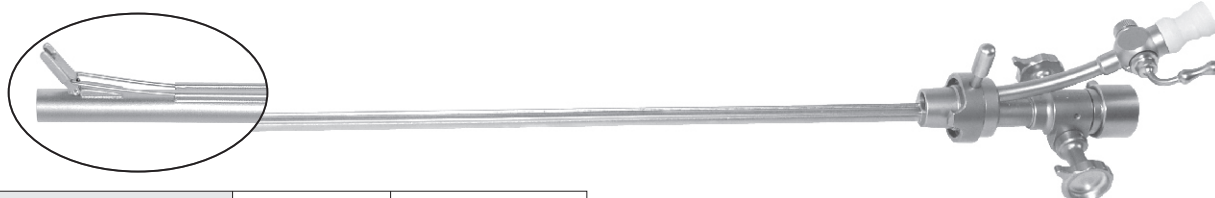

Beschreibung <i>Description</i>	mit Raste <i>with Rast</i>	ohne Raste <i>with out Rast</i>
Artikel Nr. <i>Product No.</i>	37 25 01	37 25 04

Arbeitseinsatz mit Albarran Lenkhebel, 2 Instrumenten-Kanäle *Working element with Albarran drop arm, 2 instrument channels*

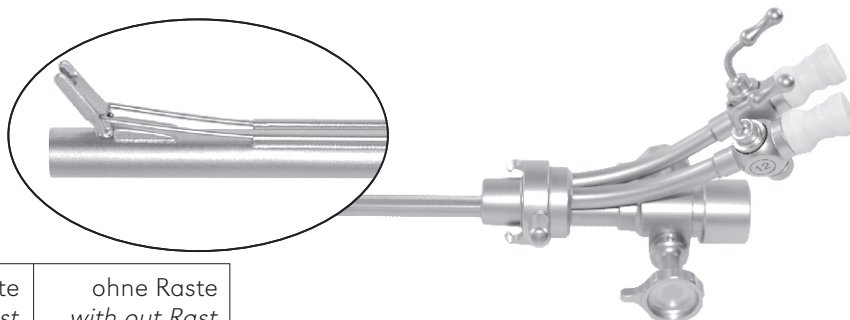

Beschreibung <i>Description</i>	mit Raste <i>with Rast</i>	ohne Raste <i>with out Rast</i>
Artikel Nr. <i>Product No.</i>	37 25 02	37 25 05

Füllstab für Albarran

Filled rod for Albarran



Artikel Nr. *Product No.*

37 25 03

	Zystoskopschäfte - Art.nr. / <i>Cystoscope sheath - order no.</i>	Albarran Lenkhebel / <i>Albarran drop arm</i>	
		1 Instrumenten Kanal / <i>1 Instrument Channel</i>	2 Instrumenten Kanäle / <i>2 Instrument Channels</i>
25 Charr.	37 50 25	1 x 12 Charr.	1 x 12 Charr. o. 2 x 8 Charr.
23 Charr	37 50 23	1 x 9 Charr.	1 x 9 Charr. o. 2 x 6 Charr.
21 Charr	37 50 21	1 x 7 Charr.	1 x 7 Charr. o. 2 x 5 Charr.
19 Charr	37 50 19	1 x 6 Charr.	1 x 6 Charr. o. 2 x 5 Charr.
17 Charr	37 50 17	1 x 5 Charr.	1 x 5 Charr. o. 2 x 4 Charr.

	Zystoskopschäfte - Art.nr. / <i>Cystoscope sheath - order no.</i>	Optikbrücke / <i>Optic bridge</i>	
		1 Instrumenten Kanal / <i>1 Instrument Channel</i>	2 Instrumenten Kanäle / <i>2 Instrument Channels</i>
25 Charr.	37 50 25	1 x 12 Charr.	1 x 12 Charr. o. 2 x 8 Charr.
23 Charr	37 50 23	1 x 10 Charr.	1 x 10 Charr. o. 2 x 7 Charr.
21 Charr	37 50 21	1 x 8 Charr.	1 x 8 Charr. o. 2 x 6 Charr.
19 Charr	37 50 19	1 x 6 Charr.	1 x 6 Charr. o. 2 x 5 Charr.
17 Charr	37 50 17	1 x 5 Charr.	1 x 5 Charr. o. 2 x 4 Charr.

Steinfänger und Diathermie Schlingen *Stone basket and diathermy loops*

Handgriff zu Dormia

Handle for Dormia

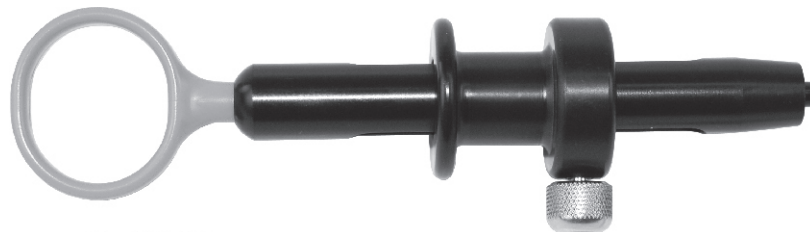

Artikel Nr. *Product No.* **37 30 01**

Handgriff zu Dormia klein

Handle for Dormia small



Artikel Nr. *Product No.* **37 30 02**

Dormia Steinfänger

Dormia stone basket

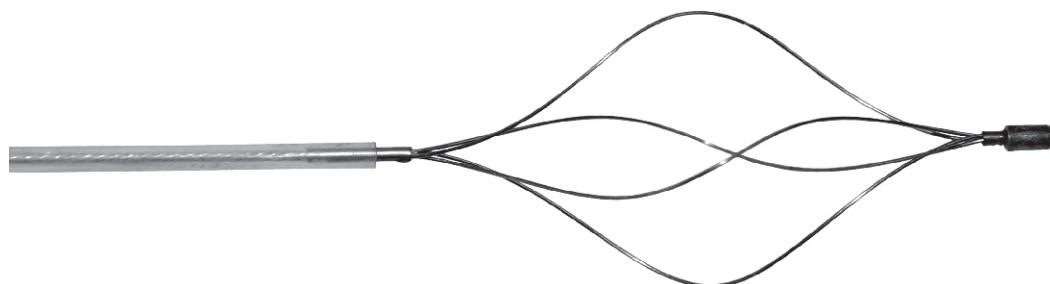

Charr.	<i>Fr.</i>	5	7	5	7	5
Drähte	<i>Wires</i>	4	4	5	5	6
Beschreibung	<i>Description</i>	ohne Griff <i>without handle</i>	ohne Griff <i>without handle</i>	ohne Griff <i>without handle</i>	ohne Griff <i>without handle</i>	ohne Griff <i>without handle</i>
Artikel Nr.	<i>Product No.</i>	37 30 03	37 30 04	37 30 05	37 30 06	37 30 07

Charr.	<i>Fr.</i>	7	3	2,5	3
Drähte	<i>Wires</i>	6	4	4	4
Beschreibung	<i>Description</i>	ohne Griff <i>without handle</i>	ohne Griff <i>without handle</i>	ohne Griff <i>without handle</i>	ohne Griff, 120 cm <i>without handle, 120 cm</i>
Artikel Nr.	<i>Product No.</i>	37 30 08	37 30 10	37 30 15	37 30 16

Teflon Tubus alleine

Teflon tube only

Charr.	<i>Fr.</i>	
Artikel Nr.	<i>Product No.</i>	37 30 09

Bestellung auf Anfrage
Order on request

Urology Zubehör Urology equipment

Steinfänger und Diathermie Schlingen *Stone basket and diathermy loops*

Handgriff mit HF Anschluss für Diathermie Schlinge *Handle with HF connection for Diathermy loop*



Artikel Nr. *Product No.*

37 30 11

Diathermie Schlinge mit Teflontubus *Diathermy loop with teflon tube*



Charr.	Fr.	5	7
Artikel Nr.	Product No.	37 30 12	37 30 13

Optische Zangen und Scheren

Optical forceps and shears

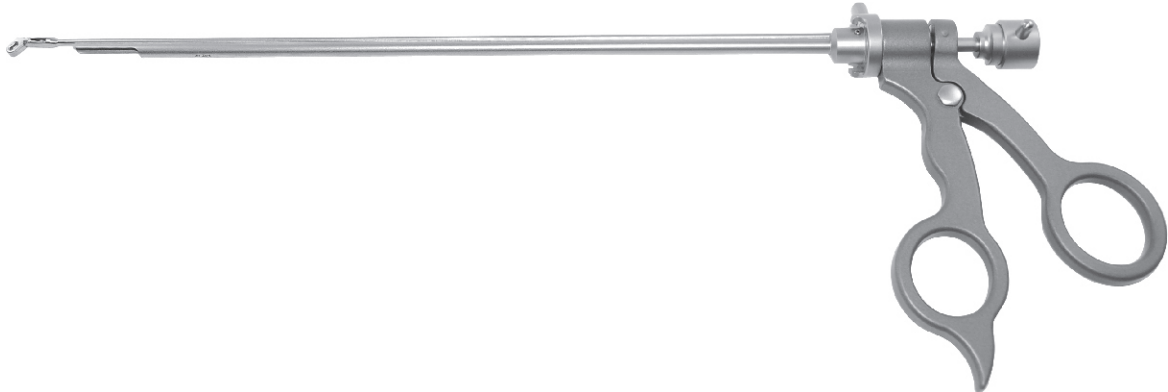

Optische Biopsiezange, löffelförmig

Optical biopsy forceps spoon

Artikel Nr. *Product No.* **37 40 01**



Optische Fasszange

Optical grasping forceps

Artikel Nr. *Product No.* **37 40 02**



Optische Standbiopsie Zange

Optical biopsy punch forceps

Artikel Nr. *Product No.* **37 40 03**



Optische Biopsiezange mit kurzen Maulteile für 70° Optik Optical biopsy forceps with short jaw for 70° optic

Artikel Nr. *Product No.* **37 40 04**



Optische Biopsiezange mit kurzen Maulteile für 12°/30° Optik Optical biopsy forceps with short jaw for 12°/30° optic

Artikel Nr. *Product No.* **37 40 05**



Optische Schere

Optical scissors

Artikel Nr. *Product No.* **37 40 06**



Urology Zubehör Urology equipment

Optische Zangen und Scheren

Optical forceps and shears

Steinzange (Lithotripsie)

Stonecrushing forceps (Lithotripsy)

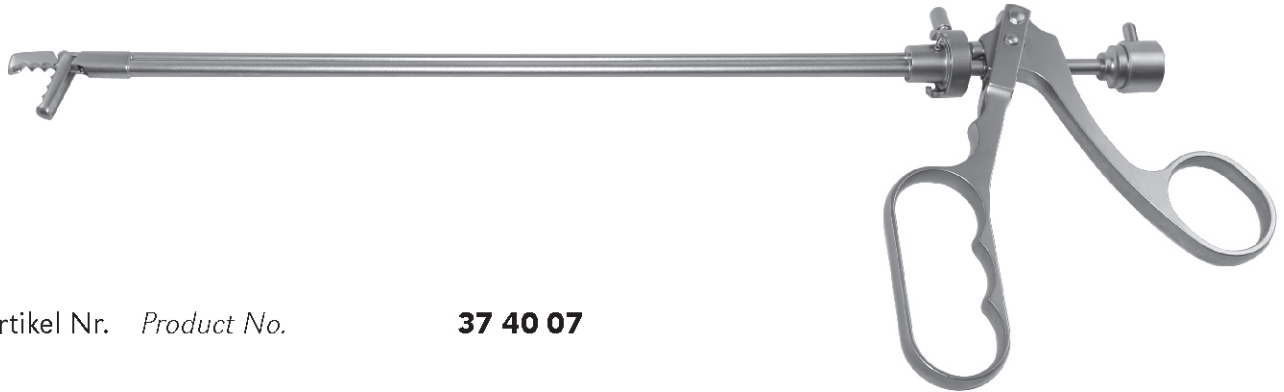

Artikel Nr. *Product No.*

37 40 07

Adapter für Steinzange

Adapter for stone crushing forceps

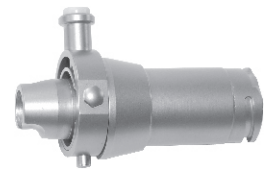

Artikel Nr. *Product No.*

37 40 09

Adapter

Adapter



Artikel Nr. *Product No.*

37 40 10

Zystoskop Adapter für Frauen

Cystoscope adapter for females



Artikel Nr. *Product No.*

37 40 11

Fasszange für Stents

Grasping forceps for stents



Artikel Nr. *Product No.*

37 40 12

Flexible Zangen und Scheren

Flexible forceps and shears

Ovaler Löffel

Oval Cup

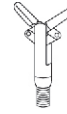
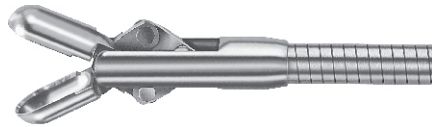
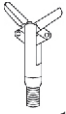

Durchmesser	<i>Diameter</i>	1,0 mm	1,0 mm	1,2 mm	1,2 mm	1,4 mm	1,4 mm	1,6 mm	1,6 mm	2,1 mm
Nutzlänge	<i>Length</i>	400 mm	600 mm	400 mm	600 mm	400 mm	600 mm	400 mm	600 mm	400 mm
Artikel Nr.	<i>Product No.</i>	37 60 10	37 60 11	37 60 12	37 70 12	37 60 14	37 70 14	37 60 16	37 70 16	37 60 21

Durchmesser	<i>Diameter</i>	2,1 mm	2,3 mm	2,3 mm	3,0 mm	3,0 mm
Nutzlänge	<i>Length</i>	600 mm	400 mm	600 mm	400 mm	600 mm
Artikel Nr.	<i>Product No.</i>	37 70 21	37 60 23	37 70 23	37 60 30	37 70 30

Ovaler Löffel, gezahnt

Oval Cup, serrated

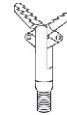
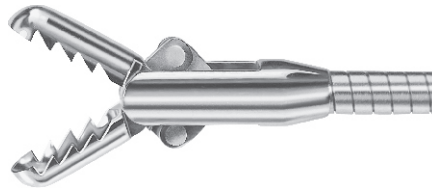
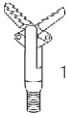

Durchmesser	<i>Diameter</i>	1,6 mm	1,6 mm	2,1 mm	2,1 mm	2,3 mm	2,3 mm	3,0 mm	3,0 mm
Nutzlänge	<i>Length</i>	400 mm	600 mm	400 mm	600 mm	400 mm	600 mm	400 mm	600 mm
Artikel Nr.	<i>Product No.</i>	37 61 16	37 71 16	37 61 21	37 71 21	37 61 23	37 71 23	37 61 30	37 71 30

Alligatormaul

Alligator Jaw

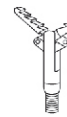
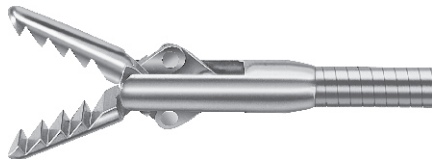
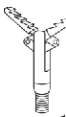

Durchmesser	<i>Diameter</i>	1,0 mm	1,0 mm	1,2 mm	1,2 mm	1,4 mm	1,4 mm	1,6 mm	1,6 mm	2,3 mm
Nutzlänge	<i>Length</i>	400 mm	600 mm	400 mm	600 mm	400 mm	600 mm	400 mm	600 mm	400 mm
Artikel Nr.	<i>Product No.</i>	37 62 10	37 72 10	37 62 12	37 72 12	37 62 14	37 72 14	37 62 16	37 72 16	37 62 23

Durchmesser	<i>Diameter</i>	2,3 mm	3,0 mm	3,0 mm
Nutzlänge	<i>Length</i>	600 mm	400 mm	600 mm
Artikel Nr.	<i>Product No.</i>	37 72 23	37 62 30	37 72 30

Fasszange, für Steinstraße feingezahnt, hohl

Grasping Forceps, for stone street, fine serrated, hollow

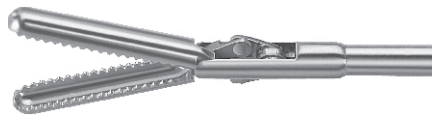

Durchmesser	<i>Diameter</i>	1,2 mm	1,6 mm
Nutzlänge	<i>Length</i>	600 mm	600 mm
Artikel Nr.	<i>Product No.</i>	37 63 12	37 63 16

Fremdkörper-Zange

Grasping forceps

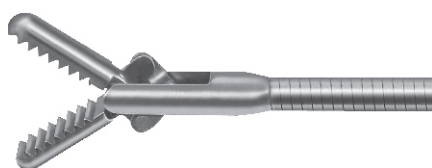

Durchmesser	<i>Diameter</i>	1,6 mm	1,6 mm	2,1 mm	2,1 mm	2,3 mm	2,3 mm
Nutzlänge	<i>Length</i>	400 mm	600 mm	400 mm	600 mm	400 mm	600 mm
Artikel Nr.	<i>Product No.</i>	37 64 16	37 74 16	37 64 21	37 74 21	37 64 23	37 74 23

Urology Zubehör Urology equipment

Flexible Zangen und Scheren

Flexible forceps and shears

Biopsiezange einfachbeweglich

Biopsy forceps single action



Durchmesser	Diameter	2,3 mm	2,3 mm
Nutzlänge	Length	400 mm	600 mm
Artikel Nr.	Product No.	37 65 23	37 75 23

Schere, einfachbeweglich

Scissors, single action

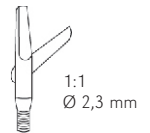
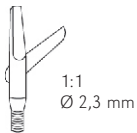

Durchmesser	Diameter	1,6 mm	1,6 mm	2,1 mm	2,1 mm	2,3 mm	2,3 mm	3,0 mm	3,0 mm
Nutzlänge	Length	400 mm	600 mm	400 mm	600 mm	400 mm	600 mm	400 mm	600 mm
Artikel Nr.	Product No.	37 66 16	37 76 16	37 66 21	37 76 21	37 66 23	37 76 23	37 66 30	37 76 30

Handgriff für flexible, isolierte und halbflexible Zangen

Handle for flexible, isolated and semi-rigid forceps

Maulteile auch ohne Handgriff erhältlich.
Standard Lieferung mit Handgriff.
Jaws also available without handle.
Standard version with handle.



Artikel Nr. Product No.

37 60 00

Flexible Zangen und Scheren

Flexible forceps and shears

Dreiarmsgreifer

3-Prongs grasper

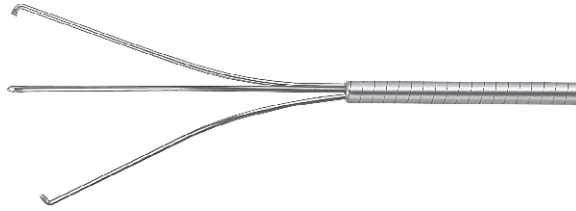

Durchmesser	<i>Diameter</i>	1,0 mm	1,6 mm	2,3 mm
Nutzlänge	<i>Length</i>	600 mm	600 mm	600 mm
Artikel Nr.	<i>Product No.</i>	37 80 10	37 80 16	37 80 23

Steinkorbchen

Stone basket

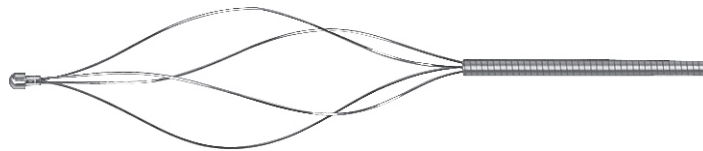

Durchmesser	<i>Diameter</i>	1,0 mm	1,6 mm	2,3 mm
Nutzlänge	<i>Length</i>	600 mm	600 mm	600 mm
Artikel Nr.	<i>Product No.</i>	37 81 10	37 81 16	37 81 23

Metallhandgriff

Stable handle (metal)

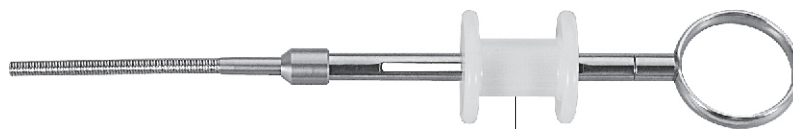

Farbcode / Colour code

- Ø 1,0 Schwarz / Black
- Ø 1,6 Weiß / White
- Ø 2,1 Grün / Green
- Ø 2,3 Gelb / Yellow
- Ø 3,0 Rot / Red

Farbcode
Colorcode